



RECOVERY, RECYCLING AND RECHARGING STATION

KK3

Use and Instruction Manual

Issue 1.0



AirSOLUTIONS

Index

1. Introduction	3
1.1 Instructions	3
1.2 Safety regulations	3
2. Outfit	1
2.1 Standard outfit	1
2.2 Quick coupling with safety hand wheel	1
3. Use	1
3.1 Preparing for use	1
3.2 Control panel description	2
4. Functions of the recharging unit	3
4.1 Brief working cycle description.	3
4.1.1 Manual cycle	3
4.1.2 Automatic mode (no access to the database)	4
4.1.3 Automatic mode (with access to the database)	5
4.1.4 Special Functions	5
4.1.5 Setup.	6
4.1.6 Info	6
4.2 Analytical description of the cycles	8
4.2.1 Manual cycle	8
4.2.2 Automatic cycle	11
4.2.3 Automatic cycle (database)	12
4.3 Settings	12
4.3.1 Date/time setting	12
4.3.2 Internal gas tank recharging.	12
4.3.3 Tare test	13
4.3.4 Language	13
4.3.5 Databank update	13
4.3.6 LCD settings	14
4.4 Remarks	14
4.4.1 Vehicles with only one connection.	14
4.6.2 Oil reservoir emptying and filling	14
5. SPECIAL FUNCTIONS	15
5.1 Printing	15
5.2 Flushing (with refrigerant)	15
5.3 Nitrogen test	16
5.4 A/C system pressures test	16
6. Service	17
6.1 Dryer filters and vacuum pump oil	17
6.1.2 Oil replacement of vacuum pump.	18
6.2 Warranty	19
6.3 Spare parts and accessories	19
6.4 Service reminder	20
6.5 Warranty sheet	21
7. Technical data	22
8. EC declaration of conformity	23
Cooling gas R 1234yf recharge and recovery unit	23

1. Introduction

1.1 Instructions

This manual has been drawn up in order to assist you in using our recharging unit for A/C systems at best and to protect your security...

We advise you to read the instructions carefully and to strictly comply with the given information.

We shall decline any responsibility resulting from the improper use of the equipment and any violation whatsoever will cancel the guarantee.

Never position the recharging unit in a horizontal way, this would give rise to oil discharge from the vacuum pump.

1.2 Safety regulations



Our recharging station is built in a way to be used by professionals adequately prepared for the use and after having read the following safety regulations and instructions;

- use the recharging unit with gloves and protective glasses,
- avoid to inhale the gas,
- avoid the contact with the skin,
- avoid the contact with the eyes,
- do not smoke whilst using the recharging unit,
- do not use the unit near flames or sources of heat,
- do not use the unit in humid and wet environments,
- use the unit in airy environments,
- only employ original spare parts and accessories,
- do not fill the stocking reservoir above 80%,
- turn off all cocks before connecting to the A/C system,
- use the recharging unit only for gas R1234yfa,
- during maintenance operations disconnect the unit from the electrical system,
- avoid to disconnect the connecting tubes if not necessary,
- Maintenance operations have to be carried out by specialized and authorized personnel.



Only use oil, additives or dye substances included in our catalogues or approved by our company. The non-observance of this rule, will
Whatsoever damage due to a wrong or improper use of the station will not be covered by our warranty. Consumables like packings and seals hoses and couplings, fuses and gauges and damages occurred during transport are not part of the warranty

2. Outfit

2.1 Standard outfit

The standard outfit is always complete and of best quality:

- n. 1 high pressure tube (red)
- n. 1 low pressure tube (blue)
- n. 1 Fitting for cylinder
- n. 1 Quick coupling R1234yfa high pressure (red).
- n. 1 Quick coupling R1234yfa low pressure (blue).

2.2 Quick coupling with safety hand wheel

The quick couplings have to be opened by screwing the hand wheels clockwise in order to avoid gas dispersion into the environment (see figure 1)



It is recommended to empty the hoses and wait for some minutes before disconnecting the quick couplings from the vehicle in order to avoid damages to the seal rings of the connections

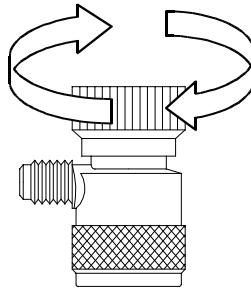

Fig. 1

3. Use



ATTENTION!

Before using the unit for the first time, unscrew the safety screw which is screwed to the load cell during transport.

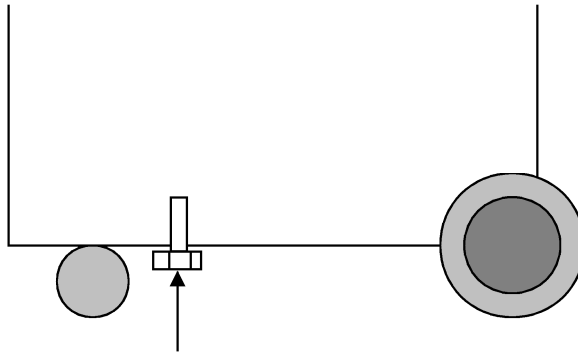

Fig. 2

3.1 Preparing for use

Connect the feeding cable to the mains (220V) and turn on the unit through the main switch.

- Make sure that the cocks are turned off.
- Check the oil levels (vacuum pump and new oil reservoir).
- After having turned on the unit, check the level of the refrigerant in the stocking reservoir through the value shown on the display.
- Make sure that the A/C system is R1234yfa and use the suitable recharging unit.
- Verify if the A/C system is of the type with 1 coupling or with 2 couplings.

Connect the tubes to the A/System, the **RED** one to the high pressure and the **BLUE** one to the low pressure, using the proper couplings. Once the connection has been carried out remember to open the couplings by using the proper hand wheels clockwise (see figure 1).

3.2 Control panel description

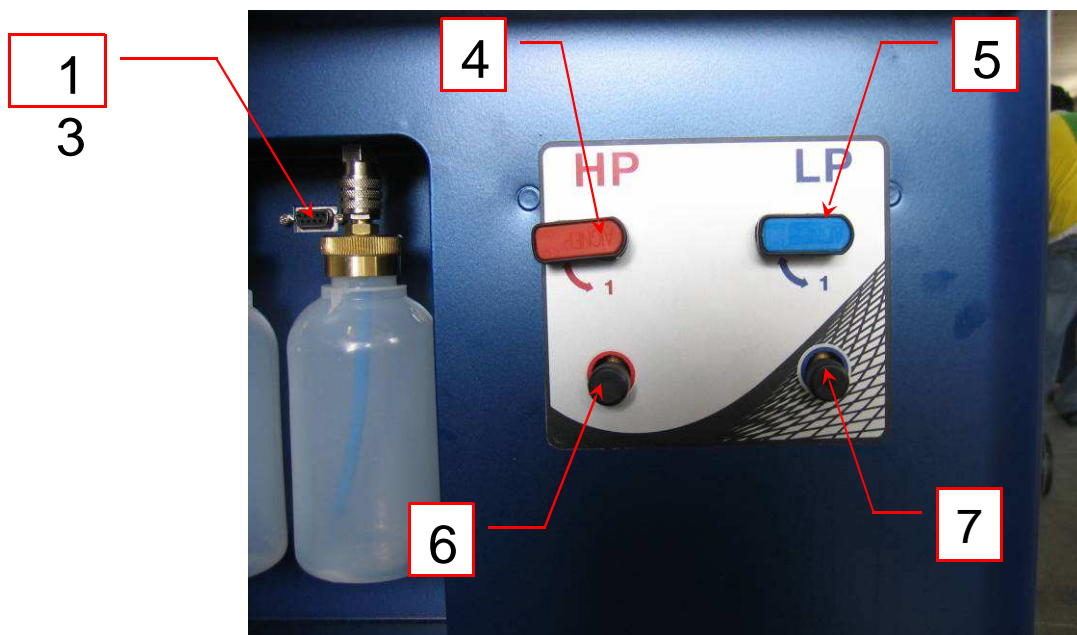
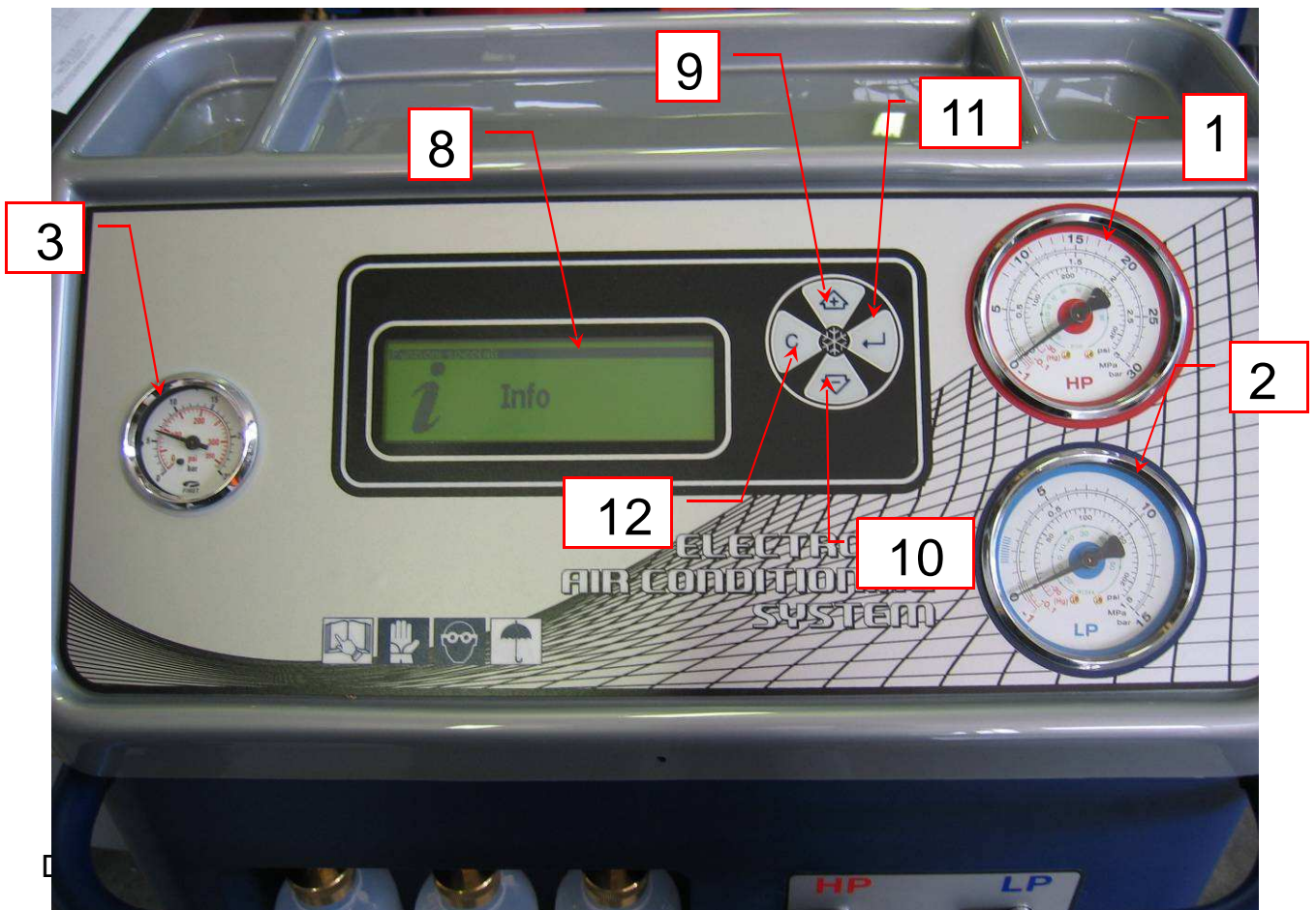





Fig. 3

The control panel has been designed in a way that every operation to be carried out is easily intuitable since all pressure gauges, buttons and cocks are coloured and equipped with symbols.

- | | |
|--|---|
| 1 – High pressure gauge: | For the inspection and diagnosis of the A/C system. |
| 2 – Low pressure gauge: | For the inspection and diagnosis of the A/C system and for the control of the vacuum. |
| 3 - Tank pressure gauge: | to check the pressure inside the stocking gas reservoir |
| 4 - High pressure valve | Connects the recharging unit to the A/C system. |
| 5 - Low pressure valve: | Connects the recharging unit to the A/C system. |
| 6 - High pressure coupling | Connects the cross-connection to the A/C system. |
| 7 - Low pressure coupling | Connects the cross-connection to the A/C system. |
| 8 - Bias lighted display: | Shows the operations of the unit on two lines. |
| 9 - Button  UP: | Shows the operation of the unit and sets the time and the quantity of gas and oil. |
| 10 – Button  DOWN: | Shows the operation of the unit and sets the time and the quantity of gas and oil. |
| 11 – Button ENTER: | Confirms the set operations. |
| 12 – Button  CANCEL | interrupts any operation |
| 13 – Serial port | Used for yearly database updating |

4. Functions of the recharging unit

4.1 Brief working cycle description.

When switched on, the unit displays the Database and allows the choice of a vehicle model to carry out the working cycle (both in manual and in full automatic mode) with the help of the stored data. The choice of the vehicle is made by selecting PRODUCER – MODEL – YEAR OF CONSTRUCTION. The database includes information regarding: A/C SYSTEM TYPE , OIL TYPE AND OVERALL QUANTITY in the system compressor and sets the working cycle data according to the GAS QUANTITY of the A/C system and the suggested vacuum and vacuum test times.

By pressing the button  it is instead possible to select the other functions of the unit:



- MANUAL OPERATION: allows to carry out working cycles, both in automatic mode (without access to the database) and in manual mode i.e. one step after the other

- SPECIAL FUNCTOINS: allows carrying out some additional functions such as a nitrogen pressure test or a flushing cycle (with refrigerant)

- SETUP: allows to configure the unit and to update the database

- INFO: offers different information such as the number of carried out working cycles, the overall quantity of recovered gas and the installed software version.

4.1.1 Manual cycle

With the help of the button , select MANUAL. With buttons  it is possible to select the following working cycles:

Description of the working cycle	Symbol
----------------------------------	--------

Gas recovery, oil separation and drain.



Vacuum



Vacuum test



Oil injection



Dye injection



Gas recharging



The working cycle includes following phases:



Phase 1: Gas recovery from A/C system, gas residuals control and recovery, oil separation and oil drain



Phase 2: Vacuum and vacuum test of the A/C system (the time is set by the operator).

Phase 3: Oil injection (by means of a solenoid valve)

Phase 4: Injection of the set dye quantity (by means of a solenoid valve).

Phase 5: Automatic gas recharging in the A/C system

With the use of the buttons   choose ENTER and the desired working phase and press





 ENTER in order to modify the values. With buttons   modify the values, if necessary.

By pressing ENTER once, the working cycle will start- By pressing the button , instead, the data are stored without starting the working cycle immediately.

4.1.2 Automatic mode (no access to the database)

At the beginning, the last recalled car model is displayed. In order to work in automatic mode without

the use of the database, press  to go back to the function choice and select "MANUAL". The different working phase's data are shown on the display

By selecting the icon  with the help of the buttons   and confirming with  ENTER all working phases are carried out in automatic mode (according to the values shown on display), i.e.

Description of the working cycle	Symbol
----------------------------------	--------

Gas recovery, oil separation and drain.



Vacuum



Vacuum test



Oil injection









Dye injection



Gas recharging





In case it is necessary to change one or more of the shown values, proceed as follows:

- select the working PHASE to be modified by means of the buttons  , confirm with "ENTER", modify the values by means of the buttons  , store the data by pressing , To start the automatic cycle, select  and press  ENTER.

4.1.3 Automatic mode (with access to the database)

At the beginning, the last recalled car model is displayed. In order to work in automatic mode with the

use of the database select the desired vehicle model by means of  , press  ENTER to reach the following menu, up to the final vehicle choice

Once the right vehicle has been selected, it is possible to start the full automatic mode by selecting



and pressing ENTER.

If, instead, it is necessary to modify one or more of the displayed values, proceed as described above (see par. 4.1.2).

4.1.4 Special Functions

The special functions include:

- a) The printing out of the working cycle data (optional)

b) The flushing cycle (with refrigerant) (optional)



c) The nitrogen pressure test (optional)



d) The working pressure test with pressure transducer for the Low Pressure side and temperature probe (optional).

NOTE: for the use of the above special functions, the unit has to be ordered with additional devices

4.1.5 Setup.



By selecting “setup” the following functions can be carried out:

Internal gas bottle recharging



Test of the electronic load cell



Language selection on display



Database updating



LCD display setting (this is carried out by the producer)

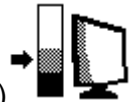

4.1.6 Info







By selecting the following statistic information are displayed:

- Recharging station model
- Software version
- Configuration
- Number of carried out recharging cycles (from last unit reset)
- Recovered (and filtered) gas quantity (from last unit reset)

4.2 Analytical description of the cycles

4.2.1 Manual cycle

Phase 1: Refrigerant recovery from vehicle A/C system and oil separation
Open the main HP and LP valves (see par. 3.2 fig. 1) (VERTICAL position)

With the help of the button  and  , select the MANUAL mode and press  ENTER;

With the button  select RECOVERY  and press  ENTER;

The recovery PHASE will start. **Note:** in case of an empty A/C system, a warning message will be shown.

At the end of the recovery cycle the unit will display the recovered gas quantity and will automatically check if there are still gas residuals in the A/C system by waiting for 2,30 minutes



Note: in case gas residuals are detected by the unit, a new recovery phase will automatically start until the gas recovery is completed at the end of the cycle the unit will automatically drain the recovered oil in the oil drain bottle (see fig. 2).

Phase 2: Vacuum and vacuum test (the length of the vacuum and of the vacuum test can be selected by the operator):

Open the main HP and LP valves (VERTICAL position)



With the buttons  and  , select MANUAL and press  ENTER;



With the button  select  VACUUM and press  ENTER;

With the buttons   choose the desired vacuum time (suggested min. vacuum time: from 20 to 30 minutes) and press  in order to store the data and follow with the vacuumj test time

selection (if the  ENTER button is pressed at his point, the vacuum and the vacuummtest will immediately start with the vacuum test time shown on the diplay);

With the help of the buttons   select VACUUM TEST-  and press  ENTER.

With buttons   choose the right vacuum test time (suggested time: from 3 to 5 Minutes) and press  in order to store the data;

By means of the buttons   select VACUUM and, after having checked the working cycle data, press  ENTER in order to start both the vacuum and the vacuum test cycles

The unit displays the time counter to the end of the cycle and the value of the pressure in the A/C system (mar)

At the end of the vacuum time, the unit will automatically start the vacuum test time and display the

time remaining up to the end of the cycle and the pressure value the end of the cycle is signalled by a warning tone...

ATTENTION: if, during the VACUUM TEST PHASE the pressure value increases and a leak in the system can therefore be supposed, the unit warns the user by displaying a warning message and emitting a continuous tone.





Phase 3: New oil / fluorescent dye injection



If necessary, at the end of the cycle, it is possible to inject new oil or/and fluorescent dye in the A/C system. To inject the oil, follow the instructions:

Open the main HP and LP valves (see par. 3.2 fig. 1)(VERTICAL position)

With the buttons  and  , select MANUAL and press ENTER;

ATTENTION: before proceeding with the Oil or dye injection check if the relevant containers (see page 14 fig. 1) are filled with a sufficient fluid quantity





With the buttons   select OIL INJECTION-  and press  ENTER;



With   choose the desired quantity and press  ENTER;
(it is suggested to inject 15 cc. more in comparison to the recovered quantity);

In order to inject fluorescent dye in the A/C system, proceed as described above with regard to oil injection, i.e.:

With the buttons  and  , select MANUAL and press ENTER;

ATTENTION: before proceeding with the Oil or dye injection check if the relevant containers (see page 14 fig. 1) are filled with a sufficient fluid quantity

With the buttons   select DYE INJECTION -  and press  ENTER;



With   choose the desired quantity and press  ENTER;
(follow the dye producer's suggestions on the quantity to be injected)

Phase 4: Refrigerant recharging into the A/C system:

Open the main HP and LP valves (see par. 3.2 fig. 1)(VERTICAL position)

With the buttons  and  , select MANUAL and press  ENTER

With   select RECHARGING-  and press  ENTER

With the help of the buttons   choose the refrigerant quantity to be recharged in the

vehicle A/C system (in grams) and press  ENTER

NOTE: During the VACUUM PHASE, the unit automatically heats the gas tank in order to increase and

hold the gas tank pressure between **6** and **10** Bar. This will allow an easy and fast gas recharging cycle, if the same is made before the pressure values decrease again. The gas tank pressure values can be checked by means of the relevant gauge on the main control board

During the recharging PHASE, the unit continuously displays the recharged quantity until the selected **quantity has been reached. The end of the cycle is signalled by a continuous warning sound**

NOTE: the gas recharging cycle is only made possible if the internal gas tank contains a min. quantity of 600 g. of gas. Otherwise, a warning message- EMPTY GAS BOTTLE! - will be displayed and the cycle will be interrupted.

IMPORTANT: The unit automatically calculates the gas quantity which will remain in the charging hoses after the recharging cycle (approx.: 100 g.).At the end of the recharging cycle the unit twill ask the operator to close the safety couplings to the vehicle LP and HP connections and, after the user

confirms by pressing on  ENTER, proceeds automatically with the gas residual recovery from the hoses.

Note: by pressing the button  every working cycle can be interrupted

Phase 5: High and low pressure control

Once the right refrigerant quantity has been recharged in the vehicle, it is possible to check the high and low pressure values of the A/C system.

Connect the A/C system to the unit and open the safety couplings (fig. 1)

“Close” the main HP and LP valves (see par. 3.2 fig. 3)(HORIZONTAL position)

Start the engine, set the A/C system to the lowest temperature setting, fan to max. speed, close external air inlets Before starting the measurements, allow the A/C system to warm up for 3/5 minutes

Check the relevant pressure gauges for HP and LP values

Note: the unit is also foreseen for the low pressure control by means of a pressure transducer. This allows displaying the value and, eventually printing it by means of the printer (optional). Select the pressure test menu (see hereunder for an analytical description of the pressure test). It is also possible to connect to a temperature probe (optional) in order to display the air temperature value.



4.2.2 Automatic cycle

Gas recovery and oil separation/drain, vacuum and vacuum test, new oil injection, dye injection, refrigerant gas recharging.







IMPORTANT the unit automatically calculates the gas quantity which, at the end of the working cycle, will remain in the charging hoses (100 g. approx.). At the end of the recharging phase, the user will be therefore asked to close (=turn counter clockwise) the couplings to the A/C system and to confirm the





procedure with  ENTER.

Open the main HP and LP valves (see par. 3.2 fig. 1) (VERTICAL position)







With the buttons  and , select MANUAL and press  ENTER



The data relevant to the different working phases are shown on the display, i.e.:

RECOVERY , VACUUM , VACUUM TEST , OIL INJECTION  ;
DYE INJECTION , GAS RECHARGING 

If all the data are correct, select the AUTOMATIC cycle  with the help of the buttons   and confirm with  ENTER. The unit will start the automatic working cycle according to the data shown on the display.

In case it is necessary to change the working data, act as follows.

With the help of the buttons   select the working PHASE to be modified, press 
ENTER, change the settings with the help of  , exit and store the data pressing on 

Once all changes have been made, select  and press  ENTER in order to start the automatic cycle.

The unit will begin with the refrigerant RECOVERY and the following oil separation phase.

Note. If no gas is detected in the lines, the unit displays "A/C system empty!" and switches to the following cycle.

At the end of the recovery cycle, the unit drains the recovered oil parts in the oil bottle and waits for 2,30 in. in order to check if there are still gas residuals in the A/C system.

Note: In case gas residuals are detected by the unit, a new recovery phase is automatically started.

When the system has been completely emptied, the recovered oil is drained in the used oil bottle (see fig. 4).

The unit then automatically switches to the VACUUM PHASE. The unit displays the time missing to the end of the cycle and the pressure values in mBar.

At the end of the vacuum phase, the unit starts the VACUUM TEST phase. On the display, the user can read the current pressure value and the time count down.

If no leak detection has occurred during the VAC TEST, the unit injects the oil and (eventually) dye.

quantity according to the previously set values. (See above page 11)

The last cycle is the RECHARGING PHASE. During the recharging, the unit displays the current, recharged, gas quantity a number of tones warn the user that the complete working cycle has been finished.

ATTENTION: if, during the VACUUM TEST PHASE, a leak is detected, the unit warns the operator with a series of tones and stops the working cycle.



Note by the use of the button  the workig cycle can be interrupted at any time.

.At the end of the working cycle, it is possible to make an A/C system pressure test (see above)

4.2.3 Automatic cycle (database)

When you switch on the unit, the last recalled car model is shown on the display.

In order to work in automatic mode with the use of **the database** select the desired vehicle model by

means of   , press  ENTER to reach the following menu, up to the final vehicle choice
Once the right vehicle has been selected, it is possible to start the full automatic mode by selecting



and pressing ENTER.

If, instead, it is necessary to modify one or more of the displayed values, proceed as described above (see par. 4.1.2).

4.3 Settings

4.3.1 Date/time setting



(the date and time settings are only necessary

If the unit is provided with a printer - (OPTIONAL).



4.3.2 Internal gas tank recharging.

If the gas quantity in the internal gas tank decreases too much, the unit warns the user to recharge the tank before starting the working cycle. In order to recharge the gas tank, act as follows::

Connect the RED/HP hose of the unit to the external gas tank, by means of the relevant adapter, part of the outfit.

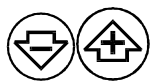
ATTENTION! If the external gas bottle is provided wit only ONE tap (usually a BLUE/LP tap) the unit has to be reversed in upside-down position, in order to recover mainly liquid gas.



With the help of the buttons select SETTINGS  and press  ENTER

With the buttons   select GAS TANK RECHARGING  - and press  ENTER



With   set the gas quantity to be recharged in the internal tank and press  ENTER

The unit automatically stops the recharging when the set quantity is reached

Close the coupling on the external gas bottle.

Close the quick coupling and recover the gas left in the hose.

4.3.3 Tare test

With the button  select - SETUP--  and press  ENTER



Pressing on  select TARE TEST -  and press  ENTER

The unit will display the current gas weight value on the top of the screen and the weight of the sample at the bottom.



The user puts a known sample weight on the gas bottle (for instance a 2 Kg. sample) and the load cell of the unit has to be periodically tested, at least once a year.

4.3.4 Language

It is possible to change the language setting of the unit s following described:



Using the button  select the option- SETUP--  and press  ENTER

Press  , select LANGUAGE -  and press  ENTER

With the button  choose your language and press  ENTER

4.3.5 Databank update

(The data bank update has to be made by authorised personnel only).

Using the button  select the option- SETUP--  and press  ENTER

Connect your PC to the unit through the serial port of the unit (the unit has to be switched off, when connecting)

Press  , select DATABANK UPDATE  and press  ENTER

Start the update program on your PC following the instructions provided with the UPDATE CD-ROM.

4.3.6 LCD settings

(for production purposes only; the settings can not be changed by the user)

4.4 Remarks

4.4.1 Vehicles with only one connection.

For vehicles which have only one connection of high or low pressure the relevant tube and quick coupling has to be used and the other cock has to be closed,.

After having carried out the above proceed with all the functions, as for a unit with two connections.

Example: Vehicle with only one connection of high pressure:

- - connect the quick coupling of high pressure (red) to the A/C system;
- - open cock of high pressure (red) and close the low pressure one (blue);
- Carry out the gas recovery phase as for a unit with 2 couplings.

4.6.2 Oil reservoir emptying and filling

Exhaust oil:

- Empty the bottle when the oil level is around 200/220 cc;
- Use adequate containers for the exhaust oil.

IMPORTANT: used oil is a special waste and has therefore to be treated in conformity with the regulations in force

New oil:

The level should never be below 100 cc.

Synthetic R1234yfa oil is recommended to be used for the system.

It is advisable to use types of oil which are recommended by the manufacturer of the A/C system

Dye:

The level should never be below 100 cc.

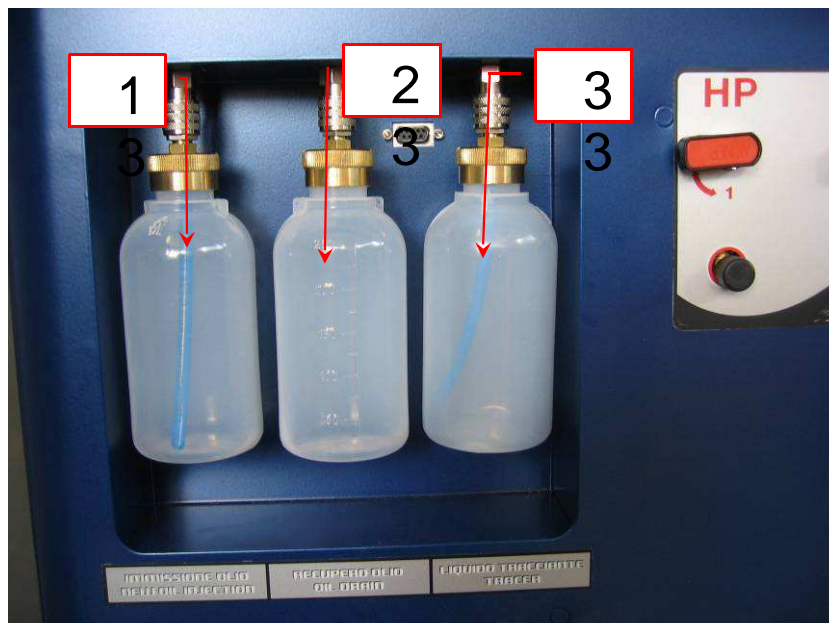

Fig. 4

1) New oil container

2) Oil drain bottle

3) Dye fluid bottle



IT IS RECCOMENDED TO USE AUTHORISED DYE FLUID ONLY. DAMAGES CAUSED TO THE UNIT BY THE USE ON NON-AUTHORISED DYE FLUIDS WILL NOT BE COVERED BY THE WARRANTY.

5. SPECIAL FUNCTIONS

5.1 Printing

(the printer is an OPTIONAL accessory which can be included in the unit or added to the unit by authorised personnel)

In order to print the data of the last working cycle, select SPECIAL FUNCTIONS , PRINT and press ↵ ENTER

5.2 Flushing (with refrigerant)

REMARKS: the flushing cycle is only made possible when the unit has been prepared for this purpose from the beginning and has been added with special parts. The flushing furthermore foresees the use of optional accessories (connections and additional filters which are not included in the standard outfit and have to be bought separately)



Close (i.e. put in horizontal position) the HP main cock, disconnect the HP hose and connect tot he additional refrigerant outlet (optional part) (the valve has to be closed when not working. DANGER: never open the valve if not necessary).



Connect the HP hose (connected to the internal gas tank) and the LP hose (connected to the usual LP inlet) to the A/C system or parts of the <A/C system by means of the universal coupling set code : 70601000 (not included in the standard outfit)

Attention: the refrigerant used for the flushing cycle is recovered in the unit and needs therefore to be filtered before being introduced in our unit. We recommend to use the filter included in the set of accessories for flushing, code no, 70601000 according with the relevant use instructions.

With the help of the buttons   select FLUSHING  and press ↵ ENTER

NOTE: It is necessary to make a vacuum cycle before starting the flushing phase in order to avoid that ait is recovered in the internal gas tank.

Set the vacuum time by means of the buttons   (suggested vacuum time is 5 min.) and the vacuum test time (to check for leaks in the A/C system-suggested test time is from 1-3 min.)

With the buttons   set the required flushing time (suggested flushing time is 20 min.), open

the connection valve to the internal gas tank (HP hose and press ↵ ENTER in order to start the flushing cycle. The unit will display the time left to the end of the cycle. It is eventually possible to print the flushing cycle data (see above for the use of the printer option)

5.3 Nitrogen test

REMARKS: the nitrogen test cycle is only made possible when the unit has been prepared for this purpose from the beginning and has been added with special parts. The test furthermore foresees the use of optional accessories which are not included in the standard outfit and have to be bought separately

With the buttons   select NITROGEN TEST-  and press ↵ ENTER

NOTE: It is suggested to make a vacuum cycle before starting the flushing phase.

Connect the external nitrogen bottle through a pressure reducer to the nitrogen inlet of the unit the suggested nitrogen pressure is from 18 to 20 Bar

Select the desired vacuum time (suggested vac. time: 5 min.), the length of the vacuum test time and the nitrogen pressure test time (suggested time: 20 Min.).

The unit will display the pressure value in the A/C system.

ATTENTION: in case the pressure drops under certain values, the unit will display a warning sign and emit a continuous warning sound.

It is eventually possible to display the data of the pressure test (see above for instructions on how to print out working data).

5.4 A/C system pressures test

Connect the unit to the A/C system and open the safety valves.

The main HP and LP ball valves have to be in “closed” position which means in horizontal position.

Start the vehicle’s engine, select min. temperature, max. fan settings”. Let the engine warm up for there to four minutes in order to allow the A/C system to reach the working pressures.

Check the High and Low pressure values by means of the relevant pressure gauge manometer (HP = red, LP = Blue)

In addition, the Low Pressure value can be red on the display, it is also possible to connect the unit to a temperature probe (optional) and measure the temperature

REMARKS: the temperature probe is an optional accessory which is not included in the standard version.

6. Service



6.1 Dryer filters and vacuum pump oil

The replacement of the filters and of the oil for the Vacuum Pump has to be carried out when the message -SERVICE- turns on.

Generally the maintenance service is recommended to be carried out by an authorized centre, which will be able to reset the service counter and allow the unit to warn you at the next oil/filter change

6.1.1 Filter replacement

The following operations have to be carried out:

- with button  select the function MANUAL and press ENTER.
- With button  select the function RECOVERY and press ENTER to completely empty out the filters.
- Take off the rear plastic case
- Unloose the relevant couplings (use a number 14 and a number 17 spanner as shown in the below figure).
- Replace filters with original ones.

ATTENTION: replace the filters with the arrow downwards (see fig. 5);
Correctly tighten the couplings.

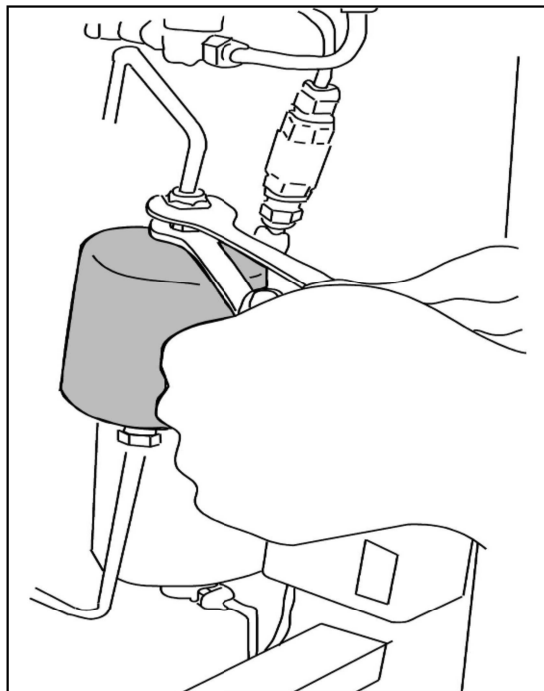

Fig. 6



It is recommended to replace both dryer filter and vacuum pump oil at least once a year.

6.1.2 Oil replacement of vacuum pump.

- Periodically check the oil level through the sight glass (3) and its purity;
- The oil level has to be at half of the sight glass;
- To reset the oil level, unscrew the plug (1) and add oil up to level (half of sight glass).
- Usually and in order to obtain a long operational life and an utmost efficiency it is recommended to replace the oil after the first 100 working hours and at the most every 12 months, or in case the oil results to be unclean and changes colour becoming dark.
- The unit, after a certain working period of the vacuum pump, automatically visualizes the message "Service" on the display. This message indicates that it is necessary to carry out the periodical control. The message disappears by pressing button ...
- Only specific lubricant has to be used (see accessories – spare parts).
- To replace the oil make the pump run for a few minutes, then unscrew the plug (2), drain the oil into a recipient, make the pump run once more for 30 seconds, let the oil drip.
- Screw the plug (2), unscrew plug (1) and introduce the necessary quantity of oil up to half the sight glass.
- Screw plug (1), make the pump run and check level.

IMPORTANT: The exhaust oil drained from the pump is a specific waste and as such it has to be collected according to the relevant regulations in force.

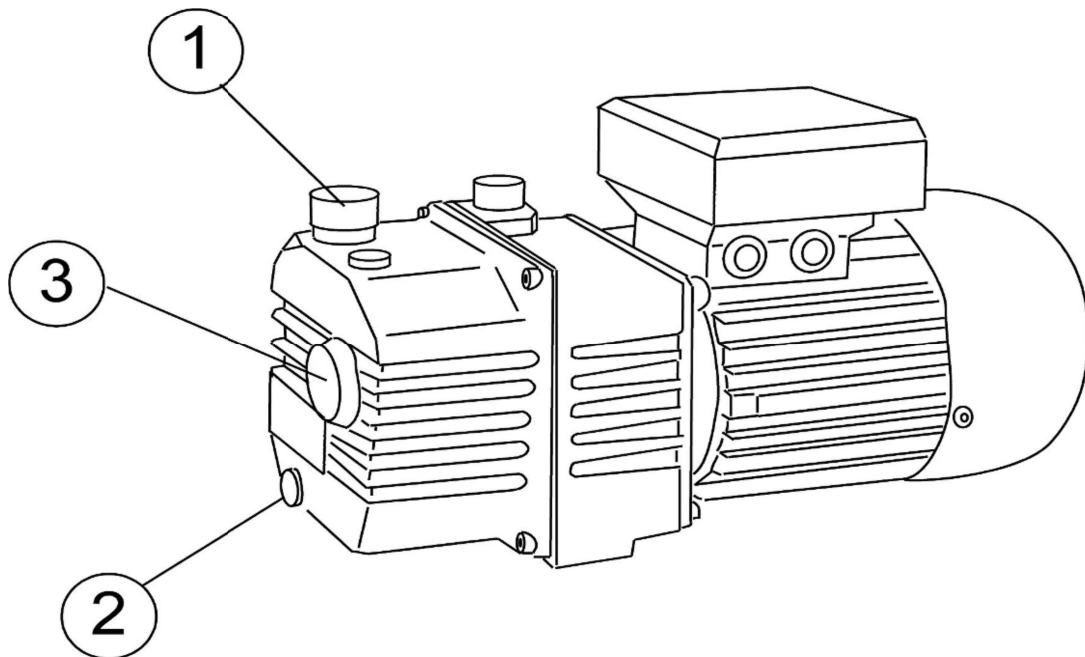

Fig. 7

6.2 Warranty

The guarantee is valid for twelve months starting from the date of the delivery note and is understood ex works Massa/Italy. The guarantee only covers failures (breakdowns) due to defective components and includes their replacement and the relevant labour costs. Problems due to incorrect use by the operator and electric parts are excluded from the guarantee.

The guarantee can be extended to three years by means of a service agreement with an authorised service centre. The agreement will include a yearly service and the use of authorised spare parts

Wrong use of the unit or use of non original spare parts is not covered by warranty. Consumables and parts subject to be regularly replaced like sealings and fuses are not covered by warranty.

The warranty is always delivered Free Ex Works Cortona Italy. Please refer to our general warranty conditions for further details

6.3 Spare parts and accessories

The use of authorised spare parts is recommended:

Dryer filter
Oil drain nottle
Oil charging bottle
Vacuum pump oil - 1 Kg
Oil for A/C systems R1234yfa 1KG

Contact your authorised dealer for additional accessories:

- LEAK DETECTION SYSTEMS
- U.V. LEAK DETECTION LAMPS
- THERMOMETERS
- HYGRO.THERMOMETERS
- FLUSHING SYSTEMS
- RETROFIT KITS
- SPECIAL COUPLINGS
- SPECIAL TOOLS
- FLUORESCENT DYE

6.4 Service reminder

WORKSHOP DATA:

MODEL

SERIAL NO.

UNIT SERVICED BY:

SERVICE OPERATIONS

DATE	FILTER	OIL	UPDATE	NOTES
	<input type="checkbox"/>	<input type="checkbox"/>	<input type="checkbox"/>	
	<input type="checkbox"/>	<input type="checkbox"/>	<input type="checkbox"/>	
	<input type="checkbox"/>	<input type="checkbox"/>	<input type="checkbox"/>	
	<input type="checkbox"/>	<input type="checkbox"/>	<input type="checkbox"/>	
	<input type="checkbox"/>	<input type="checkbox"/>	<input type="checkbox"/>	
	<input type="checkbox"/>	<input type="checkbox"/>	<input type="checkbox"/>	
	<input type="checkbox"/>	<input type="checkbox"/>	<input type="checkbox"/>	
	<input type="checkbox"/>	<input type="checkbox"/>	<input type="checkbox"/>	
	<input type="checkbox"/>	<input type="checkbox"/>	<input type="checkbox"/>	
	<input type="checkbox"/>	<input type="checkbox"/>	<input type="checkbox"/>	
	<input type="checkbox"/>	<input type="checkbox"/>	<input type="checkbox"/>	
	<input type="checkbox"/>	<input type="checkbox"/>	<input type="checkbox"/>	

- Yearly service should include AT LEAST:
- ✓ Dryer filter replacement
 - ✓ Vacuum pump oil
 - ✓ Load cell calibration test
 - ✓ Leak test with electronic leak detector

6.5 Warranty sheet

IMPORTANT

Please resend this warranty sheet by fax or e-mail to Air Solutions, div. of Seltec s.r.l., within 10 days from purchase date in order to start the warranty.

Name, surname		
<input type="text"/>		
Address		
<input type="text"/>		
<input type="text"/>		
ZIP code		
<input type="text"/>	<input type="text"/>	
State	TEL	FAX
<input type="text"/>	<input type="text"/>	<input type="text"/>

Model

Serial no.

purchase date

7. Technical data

	KK3
COMPRESSORE COMPRESSOR	1/3 hp 12 cc
POMPA DI VUOTO VACUM PUMP	140/lm 0,1 Mbar
SERBATOIO GAS STORAGE TANK	Kg 15
FILTRI FILTERS	Filtro alta efficienza Filter high efficiency
TEMPERATURA DI ESERCIZIO WORKING TEMPERATURE	Da 10°C a 50°C
TENSIONE TENSION	220-240 V 50-60 Hz
VELOCITA' DI RECUPERO RECOVERY SPEED	500 gr./min.
DIMENSIONI DIMENSIONS	470x620x1150 mm
PESO WEIGHT	Kg. 78
TIPO DI RIFRIGERANTE REFRIGERANT TYPE	R1234yfa

8. EC declaration of conformity

DICHIARAZIONE DI CONFORMITÀ CE EC DECLARATION OF CONFORMITY
--

*Noi **Air Solutions srl** – Via Gramsci, 151C 52044 Cortona (AR)– ITALY, dichiariamo che il prodotto:*

*We **Air Solutions srl**. – Via Gramsci, 151C 52044 Cortona (AR)– ITALY, hereby declare the product:*

Unità di recupero e ricarica refrigeranti R1234yf

Cooling gas R 1234yf recharge and recovery unit

nella versione distinta dal seguente nome di modello:

with the model-name:

KK3

APPLICARE QUI ETICHETTA MACCHINA CON
DENOMINAZIONE.
NUMERO DI SERIE.
ANNO DI COSTRUZIONE

al quale questa dichiarazione si riferisce è conforme agli standard richiesti dalle norme seguenti:

conforms to the standards required by the following specifications: è conforme alle disposizioni della direttiva Macchine (**N° 96/73 CE**) come modificata e recepita dalla legislazione italiana.

Complies with the **89/392 EC Directive** with emendaments.

L'apparecchiatura è inoltre conforme alle seguenti direttive CE:

direttiva 73/23 CE, come modificata e recepita dalla legislazione italiana;

direttiva 89/336 CE, come modificata e recepita dalla legislazione italiana;

The machinery also complies with the following CE Directives:

directive 73/23 EC with amendaments;

directive 89/336 EC with amendaments;

Sono state applicate le seguenti Norme Nazionali, che traspongono le Norme Armonizzate CE:

Applicable national standards and technical specifications:

UNI EN 292-1, UNI EN 292-2, UNI EN 292-2-A1;

CEI 110-1, CEI 110-7, CEI 110-8, CEI 17-44, CEI 44-5, CEI 44-6, CEI 44-7;

Cortona lì _____

FIRMA